

轨道系统 规格书

MT20S-62

— MagTrack 20 系列



◎ 基础参数

- 工艺材质: AL1070, 表面喷涂
- 外观颜色: 黑色(RAL9005)/白色(RAL9003)
- 产品尺寸: $\phi 62 \times 145 \text{mm}$
- 防水等级: IP20
- 成品色温: 2700K, 3000K, 4000K, 3000K-3800K-5000K可选
- 显指: 90
- 色容差: <3 Step (ANSI)
- 发光角度: 12°, 20°, 30°, 45° (常规版本)
15°, 24°, 36°, 50° (拨码调色温版本)
- 产品光效: 93 LM/W
- 输入电压: DC24-48V, DC48V
- 发光方向: 下发光
- 调光方式: 非调光, DALI调光, 涂鸦蓝牙, CASAMBI
- 产品应用: 室内
- 产品认证: CE, UKCA, ROHS, Reach
- 质保年限: 5年

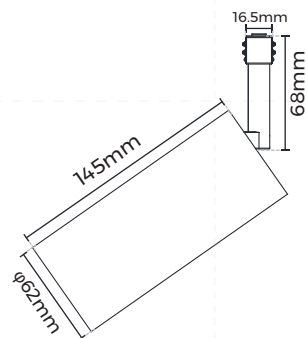

◎ 产品机械参数

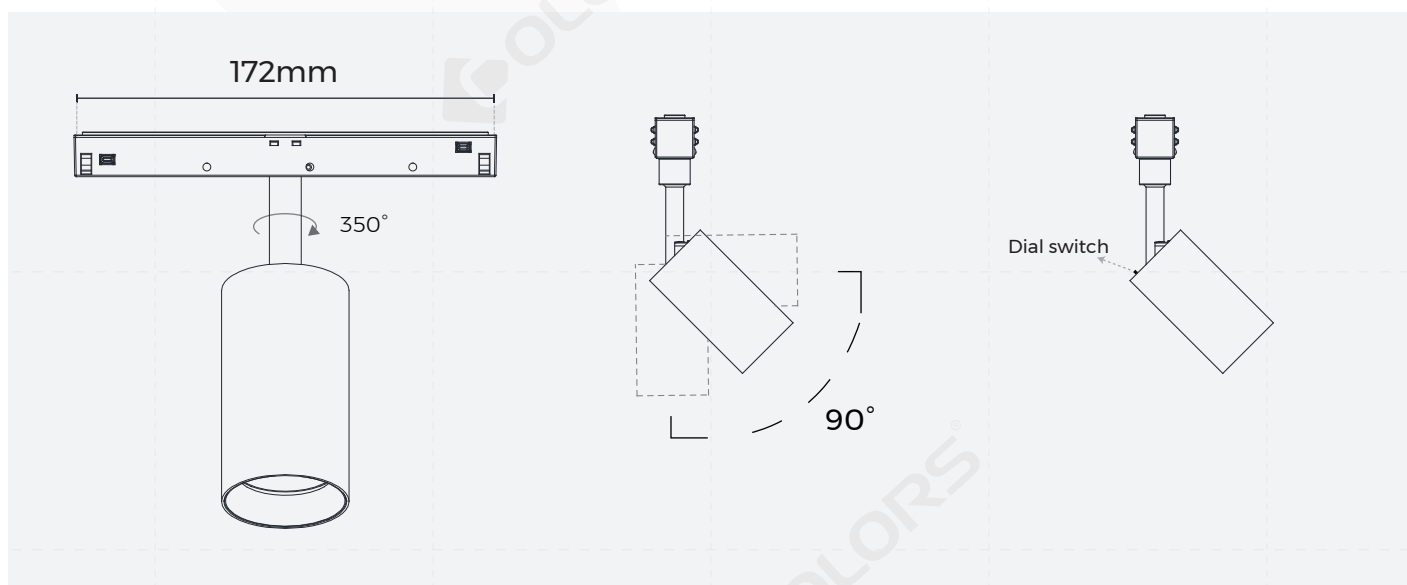

◎灯具参数

版本	商城型号	长度	输入电压 (V)	额定电流 (A)	典型功率 (W)	最大功率 (W)	显指	光束角	成品色温	流明 (LM)
常规版	MT20S-62	φ62*145mm	24-48VDC	0.625-0.31	15.0	15.0	>90	12°	2700K	990
									3000K	1045
									4000K	1125
常规版	MT20S-62	φ62*145mm	24-48VDC	0.625-0.31	15.0	15.0	>90	20°	2700K	990
									3000K	1045
									4000K	1125
常规版	MT20S-62	φ62*145mm	24-48VDC	0.625-0.31	15.0	15.0	>90	30°	2700K	965
									3000K	1020
									4000K	1095
常规版	MT20S-62	φ62*145mm	24-48VDC	0.625-0.31	15.0	15.0	>90	45°	2700K	885
									3000K	935
									4000K	1005
拨码调色温 版本	MT20S-62	φ62*145mm	48VDC	0.31	15.0	15.0	>90	15°	3000K	1125
									3800K	1320
									5000K	1200
拨码调色温 版本	MT20S-62	φ62*145mm	48VDC	0.31	15.0	15.0	>90	24°	3000K	1155
									3800K	1365
									5000K	1230
拨码调色温 版本	MT20S-62	φ62*145mm	48VDC	0.31	15.0	15.0	>90	36°	3000K	1170
									3800K	1395
									5000K	1260
拨码调色温 版本	MT20S-62	φ62*145mm	48VDC	0.31	15.0	15.0	>90	50°	3000K	1065
									3800K	1280
									5000K	1140

备注:

1. 以上参数基于Ra90,4000K色温标准灯具进行测试的结果
2. 光通量允许有±10%的容差范围;
3. 以上参数均为经典值

◎光学参数

·常规版本

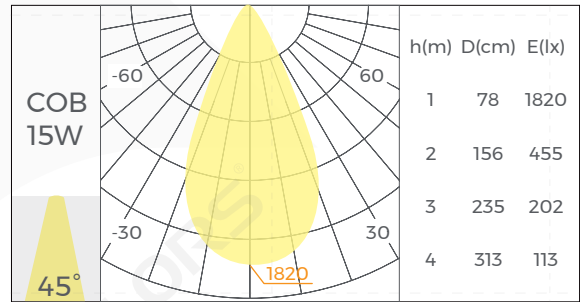
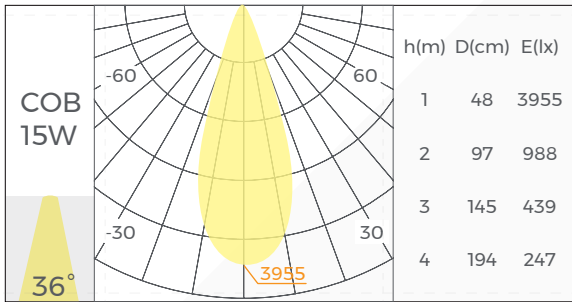
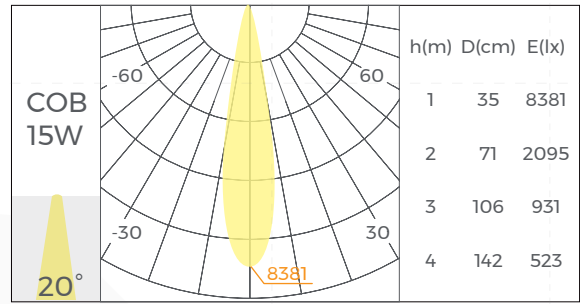
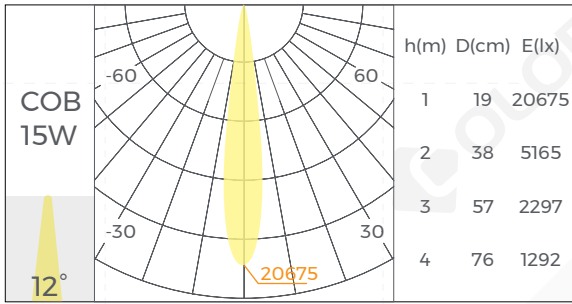

·拨码调色温版本

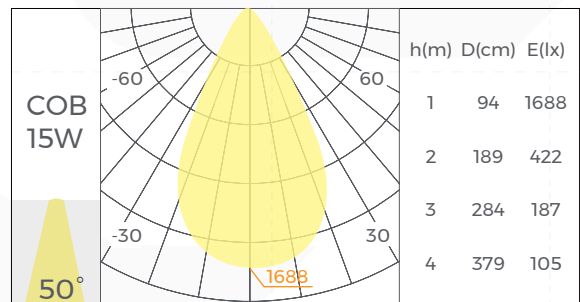
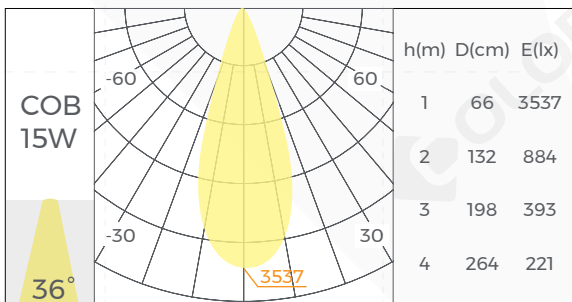
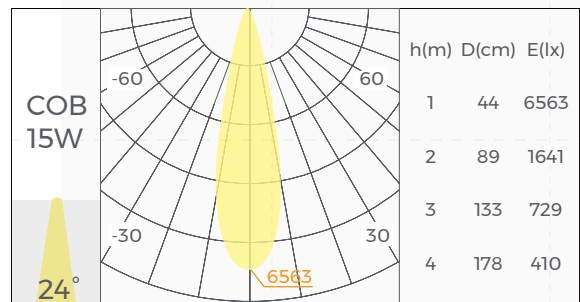
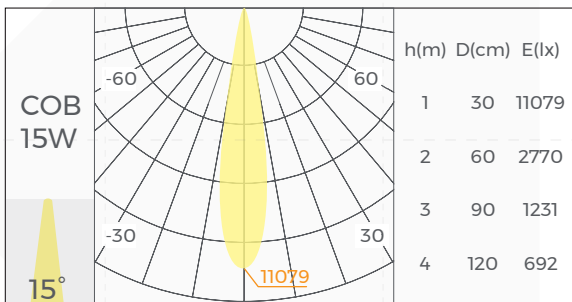

◎ MagTrack 20 产品应用

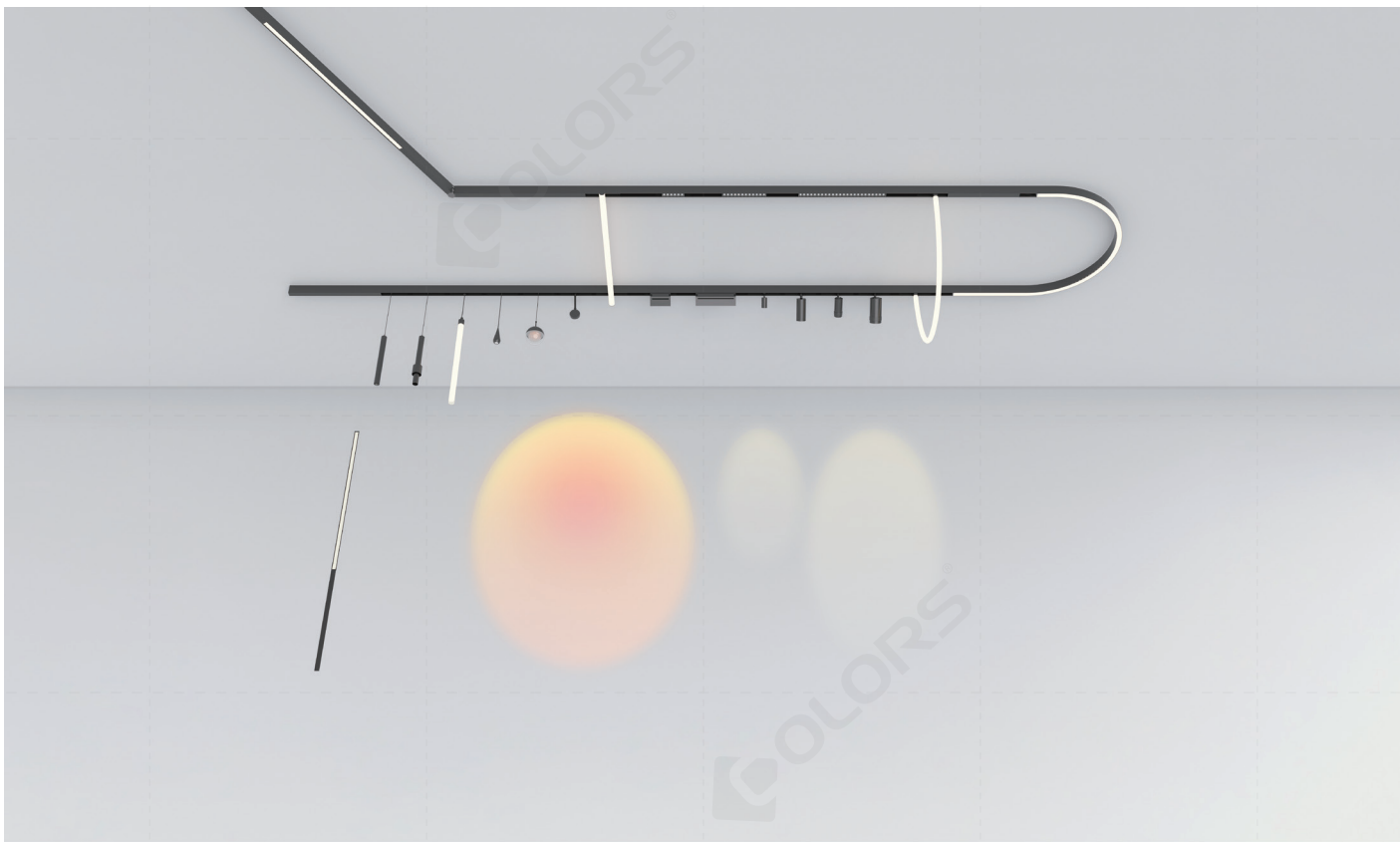

◎ 电源使用注意事项

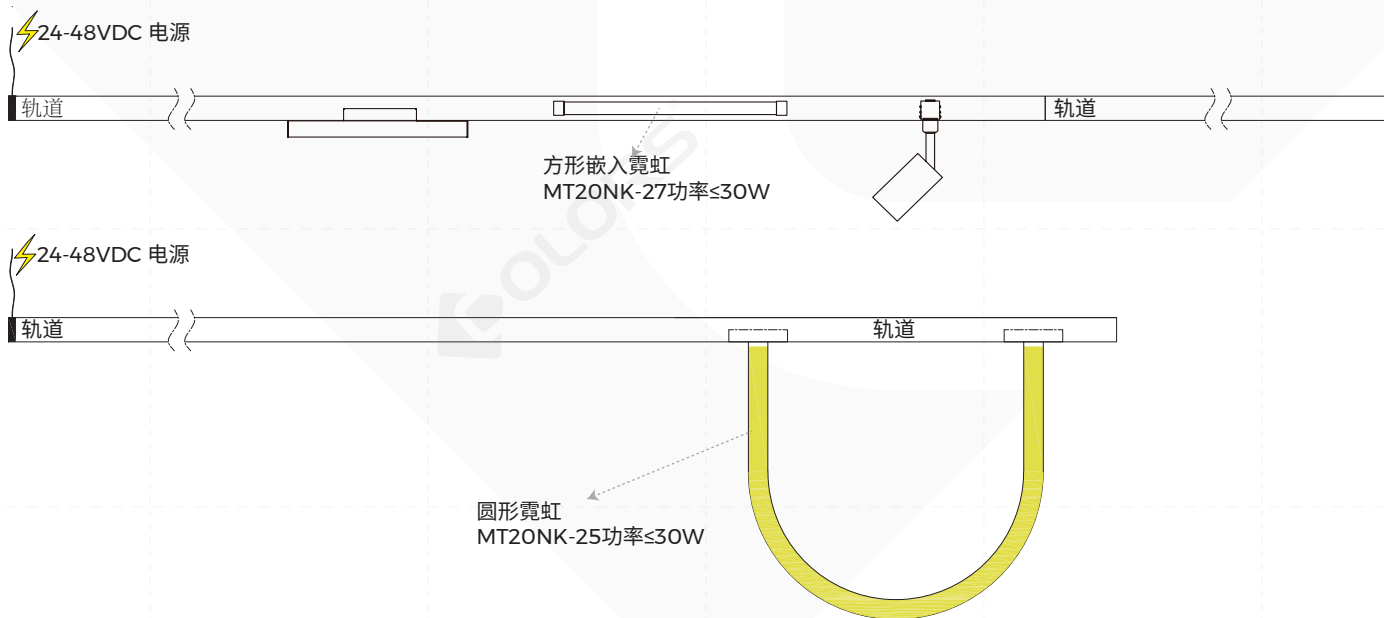

在以下任意一种情况下, 轨道条/射灯模组/线性模组/装饰模组的端头需要增加电源:

1. 方形霓虹 MT20NK-27功率 $>$ 30W;
2. 圆形霓虹 MT20NK-25功率 $>$ 30W;
3. 如果轨道用24-48VDC作为电源, 那么只能选择输入电压支持24-48VDC的灯具模组
4. 如果轨道用48VDC作为电源, 那么可选择输入电压支持24-48VDC或者仅支持48VDC的灯具模组

◎MagTrack 20 配件信息

图片	名称	商城型号
	无边嵌入轨道 (9.5mm石膏板)	TLS-MR2X0(A)
	无边嵌入轨道 (12.5mm石膏板)	TLS-MR2X0(B)
	无边嵌入轨道 (常规批灰)	TLS-MR2X0(C)
	吊装/吸顶轨道	TLS-MS2X0
	吊装/吸顶轨道	TLS-MH2X0
	φ 800mm 90° 无边嵌入弧形轨道 (9.5mm石膏板)	TLS-MR208A90(A)
	φ 1000mm 90° 无边嵌入弧形轨道 (9.5mm石膏板)	TLS-MR210A90(A)
	φ 1200mm 90° 无边嵌入弧形轨道 (9.5mm石膏板)	TLS-MR212A90(A)
	φ 800mm 90° 无边嵌入弧形轨道 (12.5mm石膏板)	TLS-MR208A90(B)
	φ 1000mm 90° 无边嵌入弧形轨道 (12.5mm石膏板)	TLS-MR210A90(B)
	φ 1200mm 90° 无边嵌入弧形轨道 (12.5mm石膏板)	TLS-MR212A90(B)
	φ 800mm 90° 吊装/吸顶弧形轨道	TLS-MH208A90
	φ 1000mm 90° 吊装/吸顶弧形轨道	TLS-MH210A90
	φ 1200mm 90° 吊装/吸顶弧形轨道	TLS-MH212A90

图片	名称	商城型号
	轨道取电器	TLS-M261
	取电器	TLS-M264
	I型取电器 (嵌入款)	TLS-M265
	I型取电器 (明装款)	TLS-M266
	堵头	EC-MR20
	堵头	EC-MS20
	堵头	EC-MH20
	轨道遮光面罩	CV-M20FB
	吸顶配件	TLS-M271
	吊绳套装	TLS-M272
	吸顶螺丝	CL-01

图片	名称	商城型号
	L型转角 (侧弯)	L90-MR20(A)
	L型转角 (内弯)	L90N-MR20(A)
	L型转角 (侧弯)	L90-MR20(B)
	L型转角 (内弯)	L90N-MR20(B)
	L型转角 (侧弯)	L90-MR20(C)
	L型转角 (内弯)	L90N-MR20(C)
	L型转角 (侧弯)	L90-MS20
	L型转角 (内弯)	L90N-MS20
	L型转角 (侧弯)	L90-MH20
	L型转角 (内弯)	L90N-MH20
	L型可调转角 (侧弯)	L90-MH20(A)
	T型可调转角 (侧弯)	T90-MH20(A)
	X型转角 (侧弯)	X90-MH20(A)

图片	名称	商城型号
	CASAMBI控制器	T200EN1812-CAS-XX-BLDAV48
	磁吸电源 (48V/100W)	MT20-HDRV100H48S-M
	磁吸电源 (48V/200W)	MT20-HDRV200H48S-M
	48V恒压电源	BN-V48-XXXP

备注:

- 1、详细参数请参考配件使用手册
- 2、配件不共用, 轨道需搭配对应的配件使用。

◎MagTrack 20产品系列经济款配件

图片	名称	商城型号
	无边嵌入轨道 (常规批灰款)	TLS-ECO-MR2X0
	无边嵌入轨道 (12.5mm石膏板)	TLS-ECO-MR2X0(A)
	吊装/吸顶轨道	TLS-ECO-MS2X0
	吊装/吸顶轨道	TLS-ECO-MH2X0
	堵头	EC-ECO-MS20
	堵头	EC-ECO-MH20
	L型转角 (侧弯)	L90-ECO-MS20
	L型转角 (侧弯)	L90-ECO-MH20
	吊绳套装	TLS-ECO-M280
	I型取电器 (明装款)	TLS-ECO-M281

备注:

- 1、详细参数请参考配件使用手册
- 2、配件不共用, 轨道需搭配对应的配件使用。

◎ NeonTrack产品应用

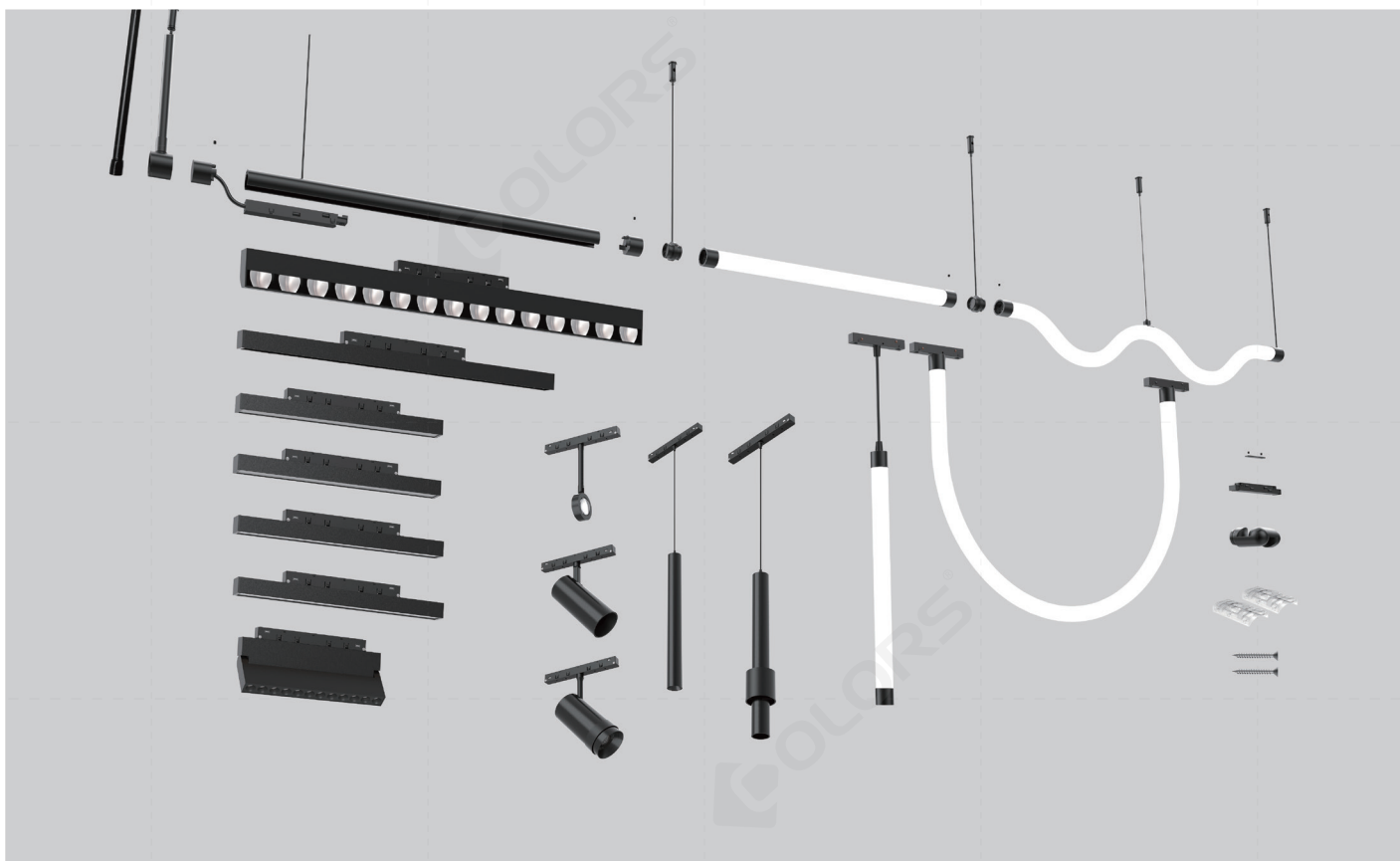

◎ 电源使用注意事项

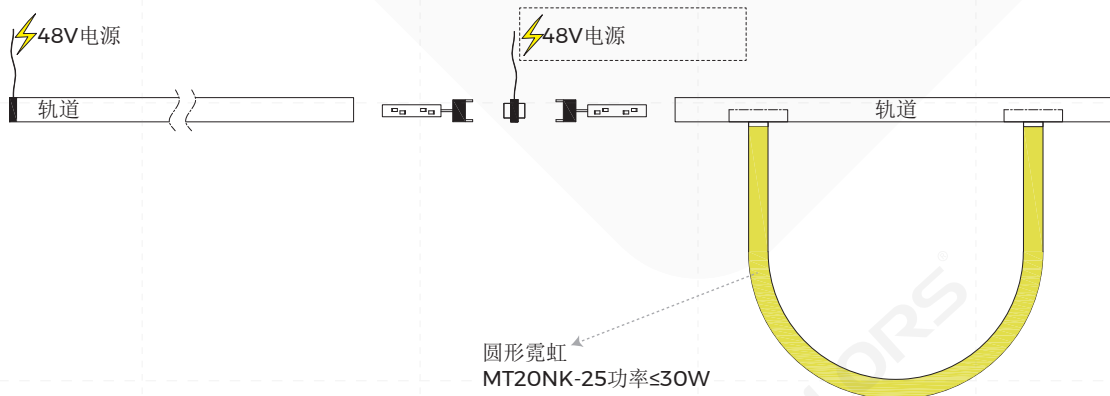
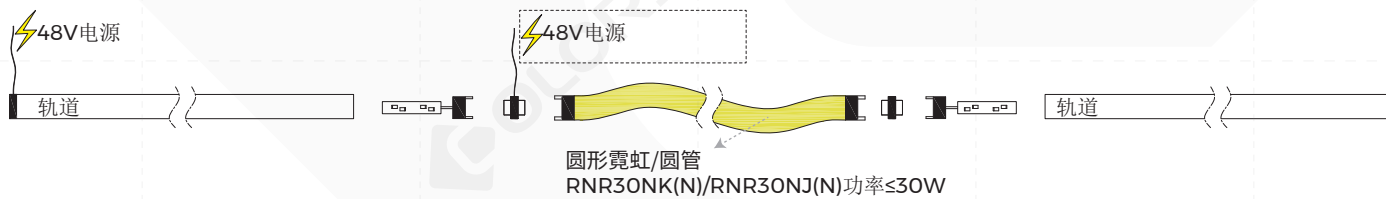
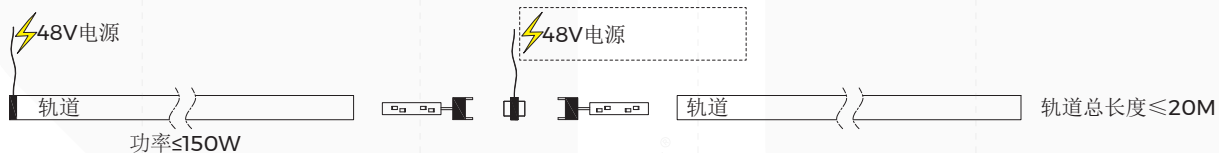

在以下任意一种情况下, 轨道条/射灯模组/线性模组/装饰模组的端头需要增加电源:

1. 轨道总功率 > 150W或者轨道总长度>20米;
2. 圆形霓虹/圆管功率 > 30W;

◎NeonTrack 配件信息

图片	名称	商城型号
	圆形轨道	TLS-R6X0
	堵头	TLS-R600
	转动连接器	TLS-R860
	直连接器	TLS-R861
	轨道取电器	TLS-R862 (N)
	I型取电器	TLS-R863 (N)
	轨道母头	TLS-R865
	吸顶螺丝	CL-21
	轨道吊杆套装	PG-I
	轨道吊绳套装	PN-D

图片	名称	商城型号
	吸顶配件套装 (霓虹软管)	CL-18
	吊绳套装 (霓虹灯)	TLS-R892
	吊杆套装(霓虹灯) (1-2米长度可调)	TLS-R893
	吊杆套装(霓虹灯) (0.5-1米长度可调)	TLS-R895
	48V恒压电源	BN-V48-XXXP

备注:

- 1、详细参数请参考配件使用手册
- 2、配件不共用, 轨道需搭配对应的配件使用。

◎包装信息

产品型号	内盒尺寸 (mm/盒)	产品数量 /盒	产品数量 /箱	净重 (kg/盒)	净重 (kg/箱)	毛重 (kg)	尺寸 (mm/箱)
TLS-MT20S62-15904036-NBB	243*206*72	1	20	0.44	8.8	13.82	503*385*434

◎产品型号

TLS	-	M	T	20	S	62	(T)	-	15	90	35	36	-	N	B	B
系统 TLS 轨道照明系统		系列 M: 磁吸模组	安装方式 T: 轨道	轨道尺寸 20: 20mm	光源类型 G: 射灯	产品尺寸 62: 4 62mm	版本 N: 常规版 T: 数码调色温版本		典型功率 15: 15W	显指 90: Ra>90	成品色温 27: 2700K 30: 3000K 40: 4000K 35: 3000K-3800K -5000K	光束角 15: 15° 20: 20° 24: 24° 36: 36° 38: 38° 50: 50°		调光方式 N: 非调光 D: 1-10V调光 A: DALI调光 X: 无调光	产品颜色 B: 黑色 W: 白色	反射器颜色 B: 黑色

◎注意事项

- 非专业人员, 禁止对产品进行安装、拆卸和维修; 灯具用于照明, 并根据电力法律法规和安装说明进行安装/拆除;
- 在安装过程中请避免对产品进行刮花、扭曲以及不规则的弯曲, 否则有可能给产品造成无法修复的损伤;
- 裁剪时请使用专业裁剪工具;
- 严禁使用任何酸性、碱性粘接剂固定产品;
- 产品仅适用于室内干燥场所, 请勿应用在户外, 海边, 潮湿浸水等环境。